

PPC2-C121-ADLP

IEI Heavy Industrial Panel PC

Powered by Intel® Alder Lake-P Platform



www.ieiworld.com



Dimensions (Unit: mm)

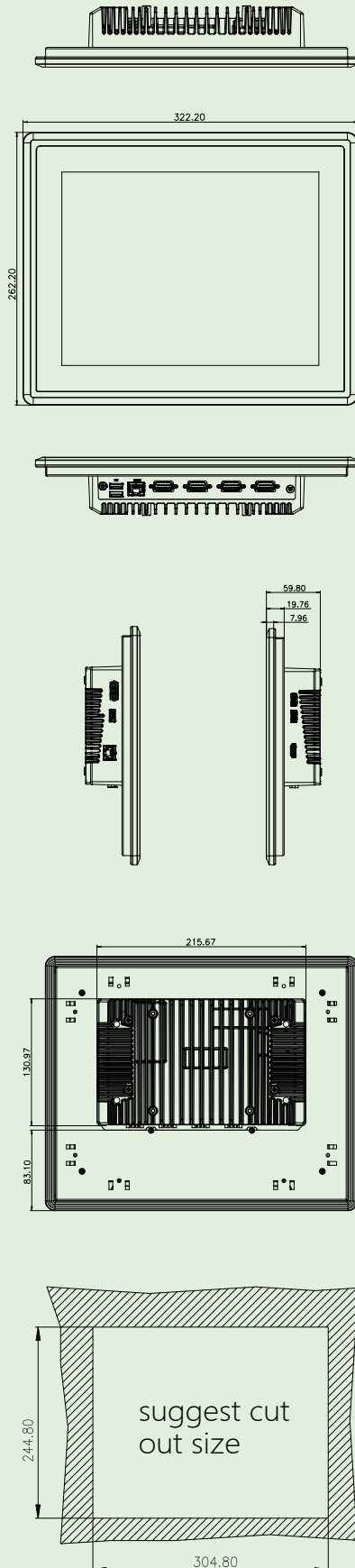

Specifications

Model	PPC2-C121-ADLP	
LCD Display	12.1" (4:3)	
Resolution	1024 (W) x 768 (H)	
Brightness	500 cd/cm ²	
Contrast Ratio	700:1	
LCD Color	16.2M	
Viewing Angle (H-V)	160°/140°	
Backlight MTBF	50,000 hours	
CPU (SoC)	12th Generation Intel® Core™ i7/i5/i3 Processor (Alder Lake-P)	
Memory	Dual-channel 8GB LPDDR4x on-board	
Touchscreen	Multi-point projected capacitive type (anti-UV / anti-glare coating, support gloves) Surface hardness: ≥7H	
Touch Controller	Projected capacitive type: EETI 80	
Ethernet	LAN1: Intel® I225V 2.5GbE controller LAN2: Intel® I225-LM 2.5GbE controller (support Intel® AMT)	
Expansion	1 x M.2 M key 2242 (PCIe Gen4 x 4) 1 x M.2 M key 2280 (PCIe Gen4 x 4)	
Mounting	VESA 100, Panel, Wall, Rack, Stand and Arm	
Construction Material	Aluminum front cover and sheet metal rear cover	
Enclosure Color	Silver+Black	
I/O Ports, Switch	2 x RS-232 by DB9 2 x RS-232/422/485 by DB9 2 x 2.5GbE RJ45 2 x USB 3.2 Gen2 2 x USB 3.2 Gen1 1 x USB 2.0	1 x HDMI output 1 x 12V DC Jack 1 x Power button 1 x Reset button 1 x AT/ATX switch
Wireless & Bluetooth	IEEE 802.11ax 2T2R module (Wi-Fi 6E) with BT v5.2 (M.2 2230 A-key)	
Thermal Solution	Fanless	
Power Input	DC 12V	
TPM	Intel® Platform Trust Technology	
Watchdog Timer	Software Programmable support 1~255 sec. system reset	
Operating Temperature (with air flow)	-10°C ~ 50°C	
Storage Temperature	-20°C ~ 60°C	
Humidity	10% ~ 95%@40°C, non-condensing	
IP Level	IP 64 compliant front panel	
Safety and EMC	CE, FCC Class A, UKCA	
Operation Vibration	MIL-STD-810G 514.6C-1(with SSD)	
Operation Shock	Half-sine wave shock 5G; 11ms; 100 shocks per axis	
Dimensions (H x W x D)	TBD	
Net Weight	TBD	
ErP	ErP 2009/125/EC	
OS	Windows 10/11 IoT, Linux	

Packing List

1 x Power Cord	1 x Power Adapter
1 x Panel Mount Kit	1 x QIG

Ordering Information

PPC2-C121-ADLP-i7/8G-R10	12.1" 500 cd/cm ² 1024x768 Panel PC with Intel® i7-1260P Processor, 8GB LPDDR4x on-board, HDMI output, black, 12V DC input, projected capacitive touchscreen with AG, R10
PPC2-C121-ADLP-i5/8G-R10	12.1" 500 cd/cm ² 1024x768 Panel PC with Intel® i5-1240P Processor, 8GB LPDDR4x on-board, HDMI output, black, 12V DC input, projected capacitive touchscreen with AG, R10
PPC2-C121-ADLP-i3/8G-R10	12.1" 500 cd/cm ² 1024x768 Panel PC with Intel® i3-1220P Processor, 8GB LPDDR4x on-board, HDMI output, black, 12V DC input, projected capacitive touchscreen with AG, R10

Options

Item	Part No	Description
Arm	ARM-31-RS	VESA 75/100 Desk Arm
Stand	STAND-C12-R10	VESA 75/100 Easy Stand
Wall Mount Kit	AFLWK-19B	Monitor Wall Mount kit
OS	TBD	TBD