

# DM2-W215K

## IEI's Latest Generation Industrial Monitor

- Front OSD, easy access for setting adjustment
- Speakers positioned at the front, ensuring clear sound delivery even in panel mount
- Supports gloved operation and waterproof protection
- Built-in camera, ideal for AI facial recognition
- USB 3.2 Gen1 Type-A supports 10W
- IP65 compliant front panel with aluminum frame
- Anti-glare and anti-UV PCAP



[www.ieiworld.com](http://www.ieiworld.com)



# DM2-W215K

The DM2 series LCD monitor is the latest member of IEI's line of sophisticated LCD designs with flat bezel. It is designed to fit industrial automation. The flat front panel provides IP 65 protection, which effectively wards off dust and water. Flexible analog or digital interfaces are provided for ease of connection with a management computer.



## Front-accessible OSD

The front-accessible OSD lets you easily control brightness, volume, and power on/off.



## Support HDMI, VGA, DP

The DM2 series offers different display interfaces, such as HDMI, VGA, and DP, to suit various requirements.



## Anti-glare and Anti-UV PCAP

With anti-glare and anti-UV coating, the 10-point touchscreen can display clearly without reflection for a long time use in outdoors and bright light environment.

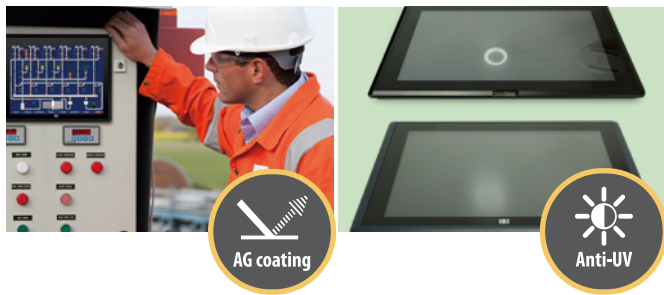

## IP65 rated front panel protection

With the IP65 front panel protection rating, this series is more durable and rugged, ensuring reliable operation in harsh industrial environments.



## Built-in Camera

The DM2 series, equipped with a built-in camera, is perfectly suited for AI facial recognition applications.

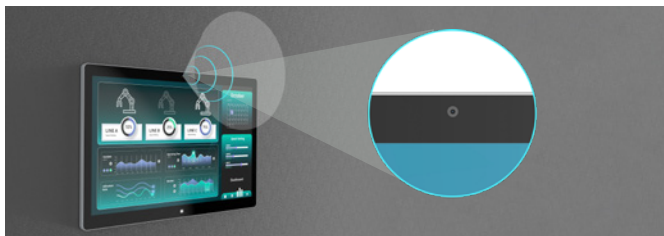

## Front Speakers

The speakers are positioned at the front to guarantee clear sound delivery, even when panel-mounted.



## Fully Integrated I/O

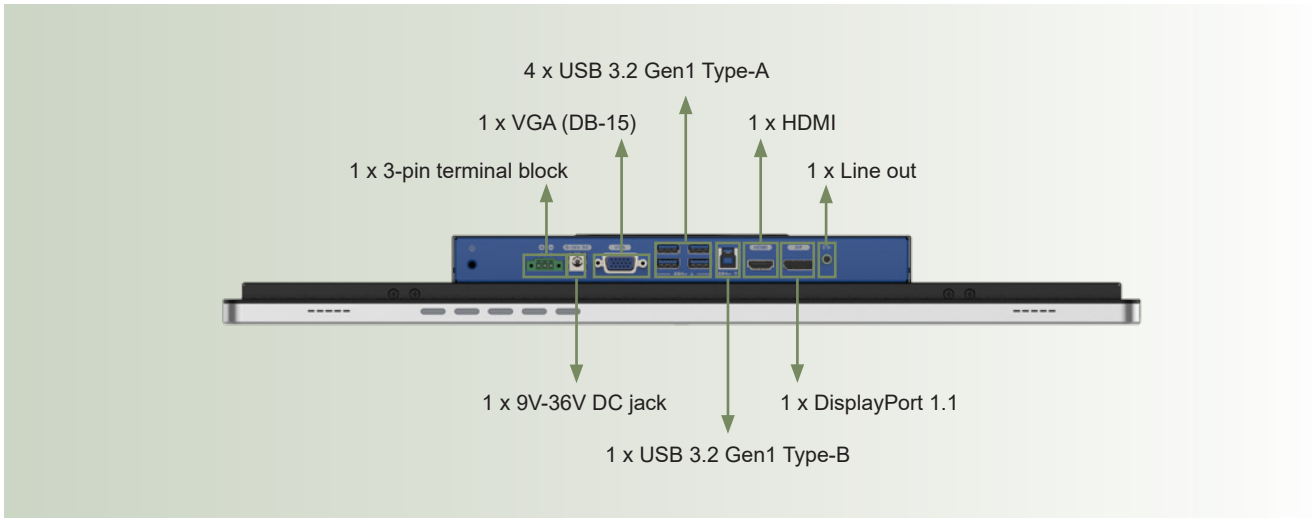

## Block Diagram

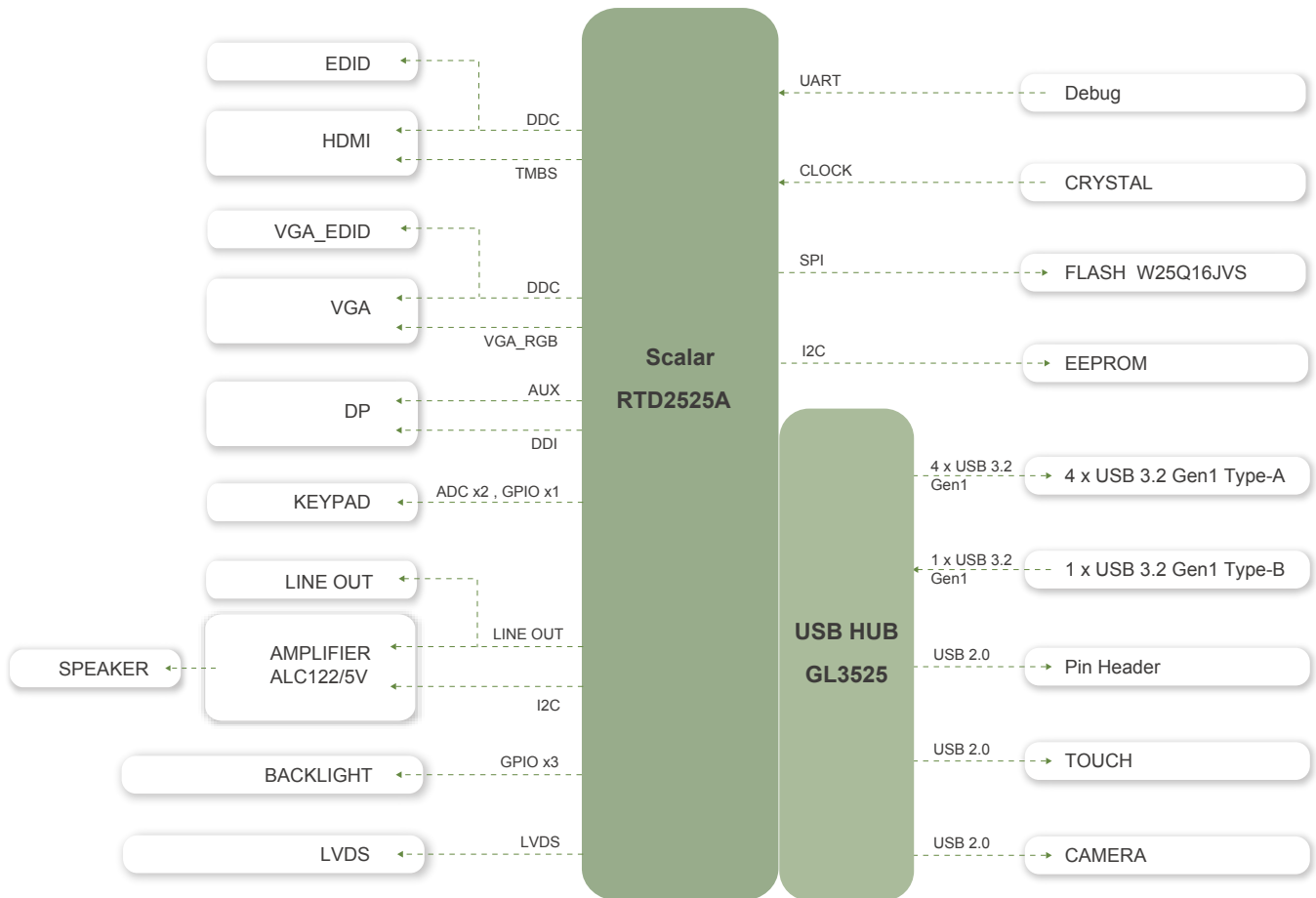

## Dimensions (Unit: mm)

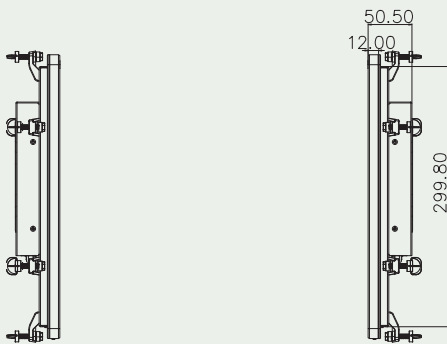
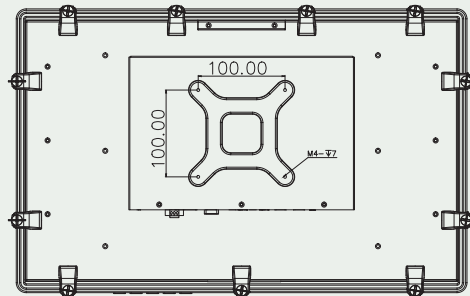
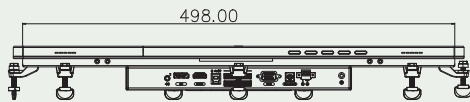
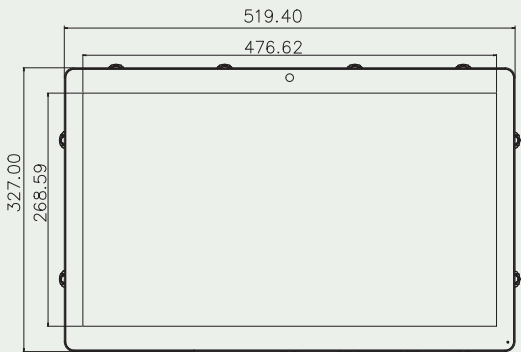

## Specifications

Model Name	DM2-W215K(L)	
LCD Size	21.5" (16:9)	
Brightness (cd/m <sup>2</sup> )	350	
Max Resolution (W-H)	1920x1080	
Contrast Ratio	1000 : 1	
LCD Color	16.7M	
Viewing Angle (H-V)	178°/178°	
Backlight MTBF (hrs)	50000	
Touch Screen	10-point projected capacitive touch window (anti-UV, anti-glare surface)	
Touch Controller	Capacitive: LiTek	
I/O Ports and Switches	1 x VGA (DB-15) 1 x HDMI 1 x USB 3.2 Gen1 Type-B 4 x USB 3.2 Gen1 Type-A *	1 x Line out 1 x DisplayPort 1.1 1 x 9V-36V DC jack 1 x 3-pin terminal block
OSD Keypad	5-key membrane OSD keypad	
Camera	Standard configuration*	
Speaker	2 x 2W AMP (internal speaker)*	
Construction Material	Aluminum front frame and sheet metal rear cover	
Mounting	Panel mount, rack mount, VESA 100	
Enclosure Color	Black	
Dimensions (LxWxH) (mm)	519.40 x 327.00 x 50.50	
Cutout Dimensions (mm)	501 x 302	
Operating Temperature	0°C ~ 50°C (with air flow)	
Storage Temperature	-20°C ~ 60°C	
Humidity	10% to 95%@40°C (non-condensing) (50%@50°C)	
Vibration	MIL-STD-810F 514.5C-1	
Shock	Operating: Half-sine wave shock 5G; 11ms; 100 shocks per axis No-operating: Half-sine wave shock 15G; 11ms; 100 shocks per axis	
IP Level	IP 65 compliant front panel	
Safety & EMC	CE/FCC/UKCA Class A	
Power Input	9~36V DC	
Power Cord	EU	

\* L (Lite) without Camera, Speaker, USB-A x 4

## Ordering Information

DM2-W215K-R10	21.5" 350 cd/m <sup>2</sup> 1920 x 1080 monitor, VGA, HDMI, DisplayPort, with USB 3.0 HUB, USB PC touch screen, 9 ~36V DC input, Speaker, Camera, R10
DM2-W215KL-R10	21.5" 350 cd/m <sup>2</sup> 1920 x 1080 monitor, VGA, HDMI, DisplayPort, with USB 3.0 HUB, USB PC touch screen, 9 ~36V DC input, Lite, R10

## Packing List

Item	P/N	Q'ty	Remark
USB-touch Cable	32001-032200-100-RS	1	USB 3.0 Type-A to Type-B cable, 100 cm
3-pin Terminal Block	33502-000188-RS	1	/
VESA Screws	44033-040062-RS	4	M.4
Panel Mount Kit	19XM0SFEE0-0004601-000-RS 19XM0SFEE0-0004602-000-RS	1	/

## Options

Item	Part No.
Stand	STAND-C19-R10; STAND-A21-R10
Wall Mount	AFLWK-19B
Power Adapter	63040-430084-000-RS; 63040-010096-050-RS; 63040-410060-000-RS (For Lite)
Power Cord	32702-000202-100-RS