

- Note:
1. Material: SECC
  2. Thickness: 1.2mm
  3. Surface treatment: original surface, no any treated.
  4. Break all sharp edges & corners, free from burrs, finished part must be free of all deburring shavings and particles.
  5. Nut & Standoff must be precisely fitted.
  6. Unspecified radius is R=2mm.
  7. Unspecified internal radius is R=0.5mm.
  8. (A) ~ (C) are critical dimensions.

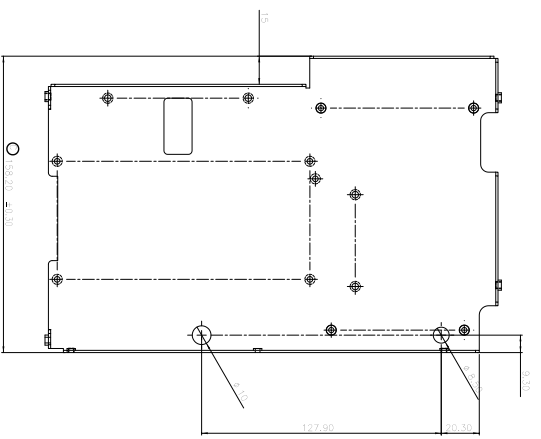
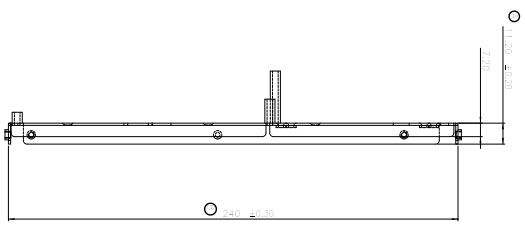
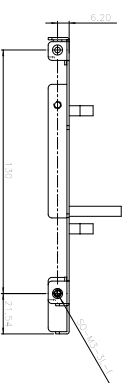
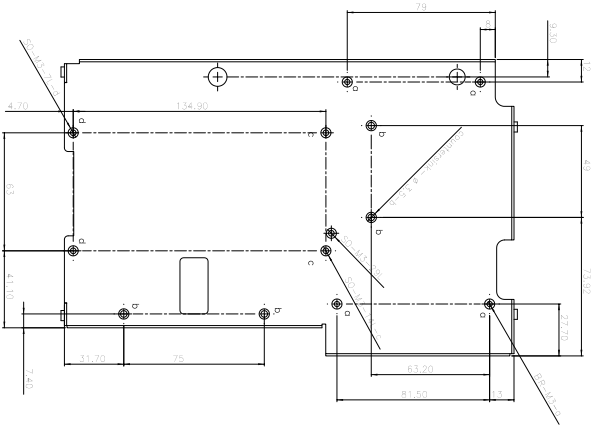
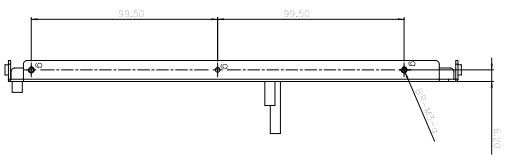
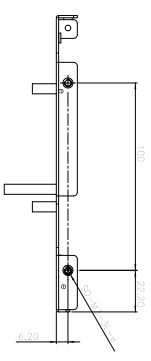
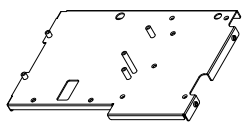

REV	DESCRIPTION	SIGN	DATE
1			
2			
3			
4			
5			

The component should be comply with the prohibit of hazardous substances in the RoHS Directive.

RANGE (mm)	Common Tolerance	APPROVE	DATE	SCALE	MODEL
0-25	±0.10	Daisy Hsu	2012.06.19	1:1	PPC-5150-H61-R10
25-80	±0.15	DESIGN Tom Lee	2012.06.19		
80-200	±0.20	DRAWN Tom Lee	2012.06.19		
200-400	±0.30				
400~	±0.40				
ANGLE	±1°				

FILE NO: 41111-0680C-00-RS	SIZE: A0	PART NO: 41111-0680C-00-RS
<b>ICP Electronics Inc.</b>		
TITLE DISK BRACKET		